

**Acrylic & Accessories**

<b>Affinity 500</b>			
Part#	Desc.	Notes	Additional Notes
800666-00	Acrylic, Intermediate	Rest on bench lamps	
1000548-00	Acry Assy Canopy Affinity 500		Everything minus display
800455-01	Acry Affinity 500	Canopy Acrylic	Only acrylic
801032-00	Sealing Profile Frame Side Section	2.3 meters per side acrylic	2.5 meters per Canopy
1509131-00	Acrylic Base Affinity 500	Customer lays on this	
86006-00	Seal Black Base Acrylic Panel	2.5 meters per bench acrylic	
51525-00	Body-Bount Rivet Black	3 Per bench acrylic & side acrylic	
51985-02	Screw M6x70 Taper H	Bench Acrylic screw	2 Per bench acrylic
800915-00	Lock Acrylic Base Ergoline	Acrylic screw washer	2 Per bench acrylic
51927-00	Cone Thrust Spring Lock Base	Acrylic Screw Spring	2 Per bench acrylic
86267-00	Insulated Cable Cover Base	Acrylic screw locking plate	2 Per bench acrylic
35178-01	Nut Insulation Panel Frame	Acrylic screw locking nut	2 Per bench acrylic
700879-00	Acrylic Side Affinity	Side Section Acrylic	Everthing minus mounting hardware
800393-00	Acrylic Panel Side Section	Side section acrylic	only acrylic
734423-02	Reflector Shoulder Tanner	Neck reflector	



**Affinity 700**

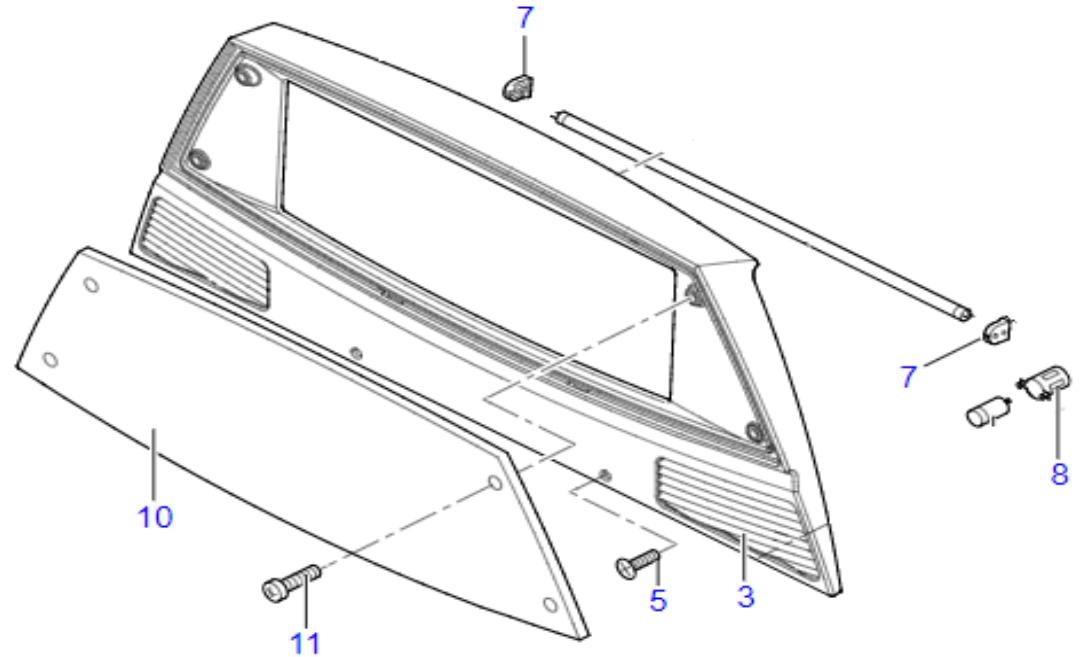

Part#	Desc.	Notes	Additional Notes
800666-00	Acrylic, Intermediate	Rest on bench lamps	
1000744-01	Base Acrylic	Customer lays on this	
86006-00	Seal Black Base Acrylic Panel	2.5 meters per bench acrylic	
51525-00	Body-Bount Rivet Black	3 Per bench acrylic & side acrylic	
51985-02	Screw M6x70 Taper H	Bench Acrylic screw	2 Per bench acrylic
800915-00	Lock Acrylic Base Ergoline	Acrylic screw washer	2 Per bench acrylic
51927-00	Cone Thrust Spring Lock Base	Acrylic Screw Spring	2 Per bench acrylic
86267-00	Insulated Cable Cover Base	Acrylic screw locking plate	2 Per bench acrylic
35178-01	Nut Insulation Panel Frame	Acrylic screw locking nut	2 Per bench acrylic

1016032-00	Canopy Acrylic Aff 700	Canopy Acrylic Assembly	Everything minus display
700879-00	Acrylic Side Affinity	Side Section Acrylic	Everthing minus mounting hardware
800393-00	Acrylic Panel Side Section	Side section acrylic	only acrylic
801032-00	Sealing Profile Frame Side Section	2.3 meters per side acrylic	
734423-02	Reflector Shoulder Tanner	Neck reflector	

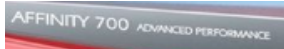
Shoulder Tanner			
Part#	Desc.	Notes	Additional Notes
12411-01	Socket Clip-On Spaghetti Lamp	Shoulder Tanner lamp holders	# 7 in image // QTY 14 per Shoulder Tanner
12125-00	Starter Holder with Spacer	Shoulder Tanner Starter holder	# 8 in image // QRY 7 per Shoulder Tanner
1001127-00	Housing ShldrTanner	Shoulder Tanner Cover	# 3 in image
51659-00	Screw 7991 M6x20	Shoulder Tanner Cover screws	# 5 in image // QTY 2 per Shoulder Tanner
800396 -00	Acrylic Neck Tanner	Shoulder Tanner Acrylic	# 10 in image
51663-00	Screw 1412 60x14	Shoulder Tanner Acrylic Screws	# 11 in image // QTY 4 per Shoulder Tanner

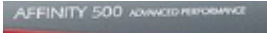

Labels			
Part#	Desc.	Notes	Additional Notes
1015442-00	AFF 700 label		
1508746-00	18+ label		
1000503-00	AFF 500 Label		
843335-01	Label FDA 12 Minutes Tanning Time	AFF 500 - Exposure Label	Must have SN# when placing order
1015649-00	Label FDA 12 Minutes Tanning Time	Aff 700 - Expsoure label	Must have SN# when placing order

Display			
Part#	Desc.	Notes	Additional Notes
1015710-00	Operating Unit Pre-Assembled	AFF 700 Display	
1507477-00	Pcb Display Ctrl Ctr	Display LCD Screen AFF 700	
1507857-01	Micro Sd Ctrl Ctr	Display Micro SD // AFF 700	
1500788-05	PCB Control Unit Affinity	AFF 500 Display	
1000507-02	Control Panel Label Ergo	AFF 500 Display sticker - membrane	

Pcb Boards - Timer			
Part#	Desc.	Notes	Additional Notes
12956-03	Pcb Fan Control Elec III		AFF 500 - 700
12955-10	Main Pcb Electronic III		AFF 500 - 700
12957-02	PCB Input/Output EIII		AFF 500 - 700
12959-02	PCB Chip Card Reader EIII		AFF 500 - 700
12129-01	PCB Temp Sensor		AFF 500 - 700

12960-02	PCB X3 Term Connection Elec 3	Coinbox PCB	AFF 500 - 700
1508990-06	Pcb Audio Controller IV	Audio PCB	Based on SN
1505334-02	Pcb Advanced Sound	Audio PCB	Based on SN
1506122-00	Timer TCM 12 Min	Timer	AFF 500 - 700
1500912-00	Circuit Board Adapter Slot		AFF 500 - 700
12240-08	PCB Facial Tanner Fan Control		AFF 500 - 700
12242-05	PCB Aqua Fresh/Fragrance	Aqua Fresh PCB	AFF 500 - 700
1507475-01	PCB Led Controller	LED Board	AFF 700 Only
12241-05	Pcb Heating Air Conditioning	AC Pcb	AFF 700 Only
1506122-00			

### Electrical Components

Part#	Desc.	Notes	Additional Notes
1024938-00	Contacto 4S 2305	Used to be 11565-00	Aff 500 // 700
12510-00	Relay 24V 60Hz USA		Aff 500 // 700
12585-01	Relay LC1D38P7 W/RC Circuit		Aff 500 // 700
11714-01	Overload Release 16A B16		Aff 500 // 700
12692-04	Circuit breaker 32A 2-pol		Aff 500 // 700
12691-03	circuit breaker 16A 2-pol UL		Aff 500 // 700
1500093-01	Transformer 100VA		Aff 500 // 700
12202-02	Interference Filter 250V 16A		Aff 500 // 700
12381-01	Relay LC1D18P7 W/RC circuit		Aff 500 // 700
12395-00	Bal 100W 230V 60Hz Screw Conn.		Aff 500 // 700
12483-01	Ballast 140 Watt 20 VAC 60HZ		Aff 500 // 700
12396-01	Ballast 160W 230V 60HZ		Aff 500 // 700
11604-00	Capacitor 45MF		Aff 500 // 700
1504802-00	Temp Switch Man Reset 60°C		Aff 500 // 700
1508004-00	Thermostat W/Manual Reset 70°C		Aff 500 // 700

**Fan - Blowers**

Part#	Desc.	Notes	Additional Notes
11713-01	Fan, Body Blower 60HZ	Body // Face fan	AFF 500 // 700
11245-00	Capacitor 3uF 400V AC	Body // Face fan startup capacitor	AFF 500 // 700
12873-02	Main Fan Ebm		AFF 500 // 700

**Lampholders - Facial components**

Part#	Desc.	Notes	Additional Notes
13038-02	Lamp Holder with Starter Base		
13037-03	Lamp Holder W/O Starter		
1001526-02	Filterglass Coated	Facial Filter Glass	AFF 700
1502704-01	Lampholder HP Lamp		AFF 500 // 700
13016-00	Fan Facial Tanner	Facial Fan	AFF 500 // 700
12404-00	Ignitor, 520W 50/60Hz		AFF 500 // 700
11239-00	Temp Sensor 70°		AFF 500 // 700
1000595-00	Lampholder Black	Spaghetti lamp - Lamp holder	AFF 700
12125-00	Starter holder with Spacer	Spaghetti lamp - Starter holder	AFF 700
1001069-01	Filter Glass UP511H 320x264	Facial Filter Glass	AFF 500